

2008 MD250H SET-UP INSTRUCTIONS

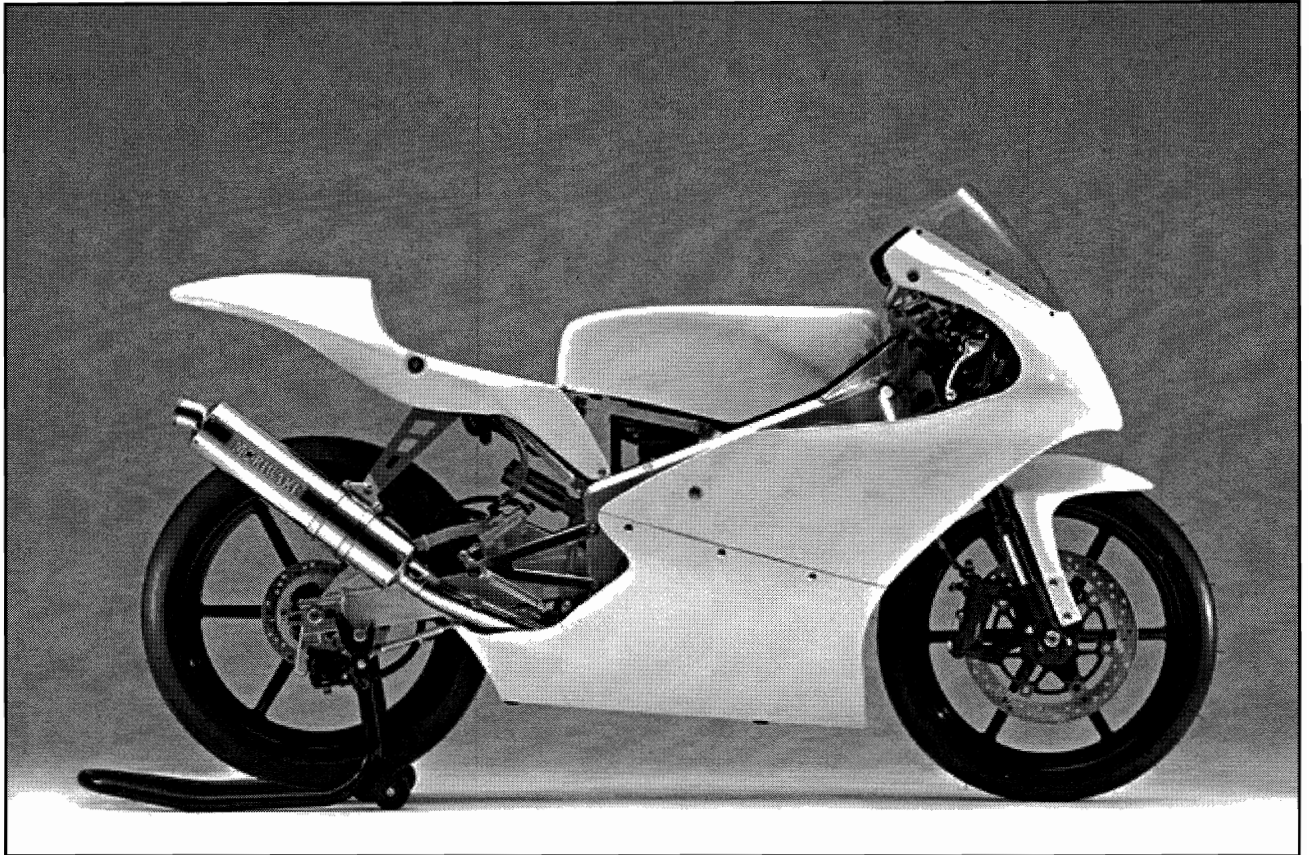

**Set-up and pre-delivery service
must be performed by an authorized
Honda motorcycle dealer.**

(

(

(

(

(

(

(

IMPORTANCE OF PROPER SET-UP AND PRE-DELIVERY SERVICE

FOR YOUR CUSTOMER'S SAFETY

Proper set-up and pre-delivery service are essential to rider safety and the reliability of the machine. Any error or oversight made by the technician assembling and servicing a new machine can result in faulty operation, damage to the machine, or injury to the rider.

WARNING

Improper set-up or pre-delivery service can create an unsafe condition that can cause your customer to be seriously hurt or killed.

Follow the procedures and precautions in this manual and the Service Manual carefully.

FOR YOUR SAFETY

Some of the most important safety precautions are given below. However, we cannot warn you of every conceivable hazard that can arise in performing set-up and pre-delivery service. Only you can decide whether or not you should perform a given task.

WARNING

Failure to properly follow instructions and precautions can cause you to be seriously hurt or killed.

Follow the procedures and precautions in this manual carefully.

IMPORTANT SAFETY PRECAUTIONS

Make sure you have a clear understanding of all basic shop safety practices and that you are wearing appropriate clothing and safety equipment. When performing the set-up or pre-delivery service, be especially careful of the following:

- Read the instructions before you begin, and make sure you have the tools and skills required to perform the tasks safely.
- To prevent the machine from falling on you, park it on a firm, level surface, using the proper stand(s) to provide firm support.

Make sure the engine is OFF before you begin any servicing procedures. This will help eliminate several potential hazards:

- **Carbon monoxide poisoning from engine exhaust**—be sure there is adequate ventilation whenever you run the engine.
- **Burns from hot parts**—let the engine and exhaust system cool before touching.
- **Injury from moving parts**—do not run the engine unless the instruction tells you to do so. Even then, keep your hands, fingers, and clothing away.

To reduce the possibility of a fire or explosion, be careful when working around gasoline or batteries. Use only a nonflammable solvent, not gasoline, to clean parts. Keep all cigarettes, sparks and flames away from the battery and all fuel-related parts.

2008 MD250H

How To Use This Manual

Follow the complete sequence of steps as shown. Do not short-cut any steps. The sequence has been established to ensure the unit is properly assembled.

The individual steps are composed of three components:

- **Sub-heading**—The large sub-headings are a brief description of the step. They are intended to be used by the experienced technician, one who only needs a brief reminder of the set-up sequence.
- **Descriptive text**—The descriptive text explains in detail what is to be done during that step. This explanation is intended as a guide for the technician needing additional information.
- **Photographs/Line art**—The photographs or line art support both the sub-headings and the detailed text.



Indicates the set-up section



Indicates the pre-delivery section

Modifications and Accessories

Modifications that you may have made, or should make in the future, to any Honda product, shall be deemed by our company to have been performed at your sole risk and responsibility, and without our company's or the manufacturer's approval, or consent, implied or expressed. We further disclaim any and all liability, obligation, or responsibility for any defects of modified parts or of the modified product, and for any claims, demands, or causes of action for damage to property or for personal injuries resulting from the modification of said Honda product.

Torque Table		
ITEM	SIZE	TORQUE
Rear axle nut	—	51 ft·lbs (7.0 kg·m, 69 N·m)

Important

This machine is designed and manufactured for competition use only and is sold "as-is" with no warranty. It does not conform to federal motor vehicle safety standards, and operation on public streets, road, or highways is illegal.

State laws prohibit operation of this vehicle except in an organized racing or competitive event upon a closed course which is conducted under the auspices of a recognized sanctioning body or permit issued by the local governmental authority having jurisdiction.

First determine that operation is legal.

Operator only, no passengers.



1. Remove the carton cover.

The MD250H is crated at the factory in a covered crate.

Remove the carton cover.

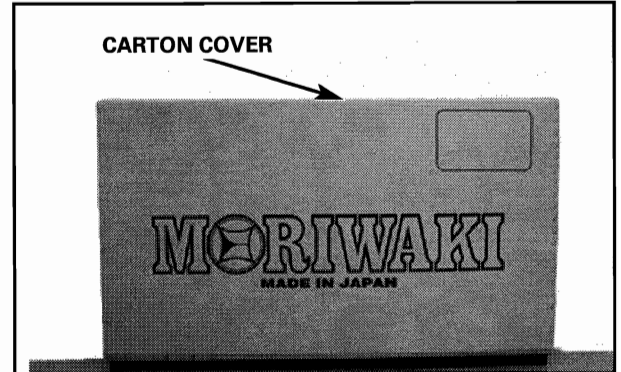

2. Check for damage.

Check the motorcycle for damage.

If you find damage, follow the instructions in the "Delivery and Damage Claims Guidelines" wall chart (Reorder No. S0477) before proceeding.

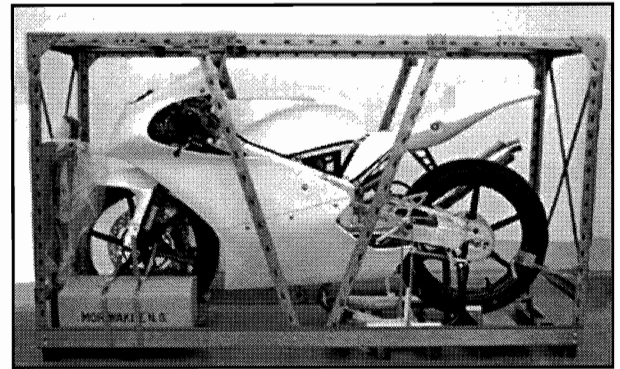

3. Remove the front stand and parts carton.

PARTS	QTY
Stand, front	1
Loose parts box	1

Cut the tie and carefully remove the front stand.

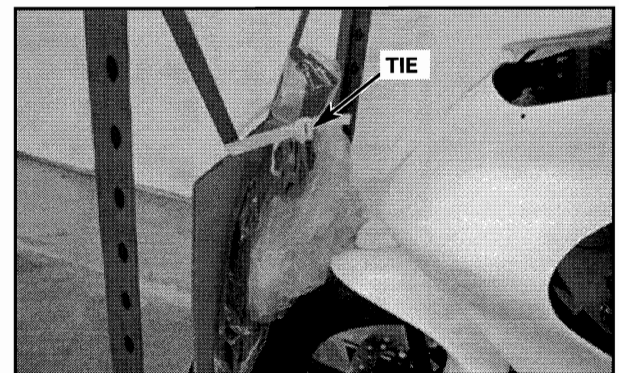

Cut the ties and remove the loose parts box.

Keep the stickers, key holder, *Service Manual/ Owner's Manual*, and the Parts Catalog CD from the loose parts box and hand deliver them to the customer at the time of delivery.

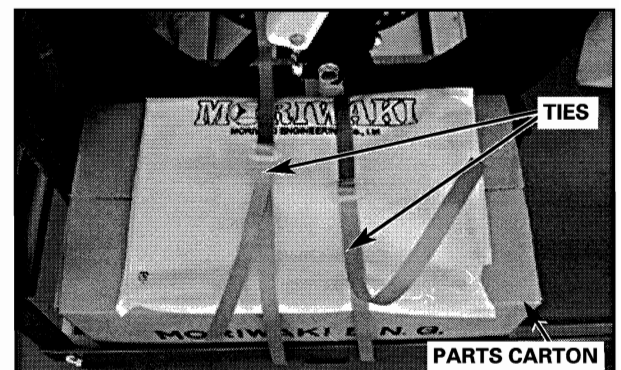

2008 MD250H

4. Loose Parts Information.

Unpack the remaining loose parts and check them against this illustration.

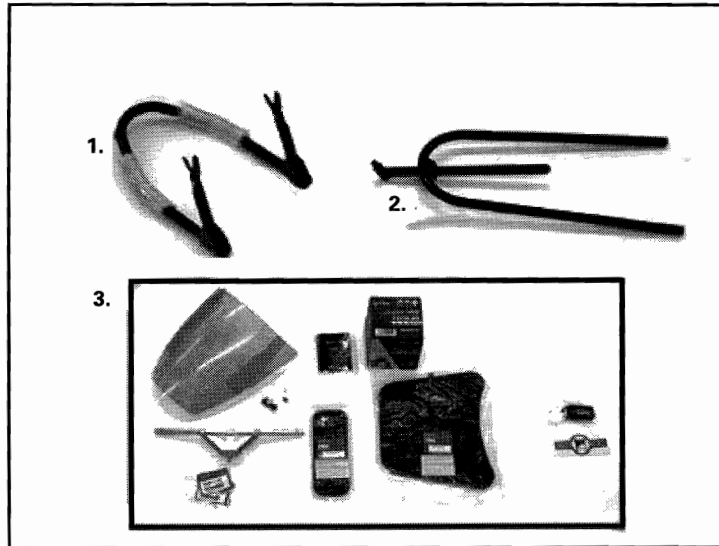

	DESCRIPTION	REF	QTY	PART NUMBER	STEP
1.	Stand, rear	[M]	1	52500-10512-00	6
2.	Stand, front	[M]	1	53500-10512-00	3
3.	<i>Loose parts box:</i>				3
	Moriwaki stickers		2	-----	3
	Powered by: Honda stickers (not shown)		2	-----	3
	Key holder		1	-----	3
	Service Manual (not shown)		1	-----	3
	Parts List CD-ROM (not shown)		1	-----	3
	<i>Windscreen kit:</i>				
	- Windscreen	[M]	1	64200-10512-00	24
	- Rivet, 4 x 7 mm	[•]	7	90656-NX4-000	24
	- Rivet, 4 x 8 mm	[M]	1	90656-40080-00	24
	<i>Upper stay:</i>				
	- Stay, front cowl upper	[M]	1	64240-10512-00	25
	- Pin, lock		2	94252-16100	25
	Rubber, seat	[•]	1	77220-NX4-000	7
	Rubber, back seat	[•]	1	77221-NF5-760	7
	Battery (YTX5L-BS)		1	31500-KY4-905	10
	Rubber, battery cushion	[M]	1	18933-10512-00	10

NO TOOL KIT INCLUDED WITH THIS MODEL.



Missing Parts or Shipping Damage

Identify missing parts by referring to the *Loose Parts Information* section. Order the parts by following the ordering procedures below. Claims for missing loose parts or those damaged during transit should be submitted to American Honda, not the carrier. After completing repairs, submit a Transportation Claim via **IN**. For complete details, please refer to the *Warranty Policy and Procedures Manual*.

Ordering Procedures:

The following notation indicates which type of part and where to order them.

[M] MORIWAKI parts

These parts must be ordered through an approved Honda dealer, from Moriwaki.

Fax: +81 (0) 59-370-0152

Email: overseas-dealer@moriwaki.co.jp

[●] HRC parts

Use normal Honda parts ordering procedures for these parts.

[] Honda Genuine Parts

Use normal Honda parts ordering procedures for these parts.

2008 MD250H

5. Remove the crate frame.

Remove the two nuts from the front shipping brace.

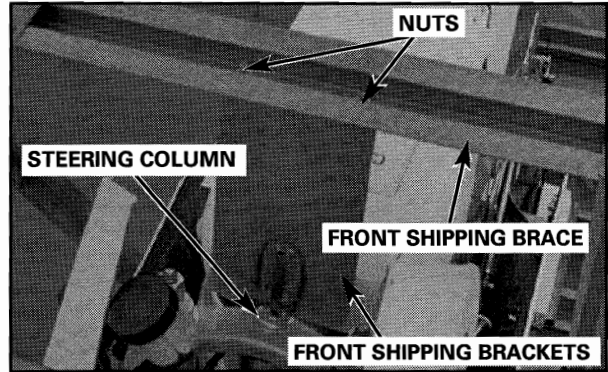

Cut the tie.

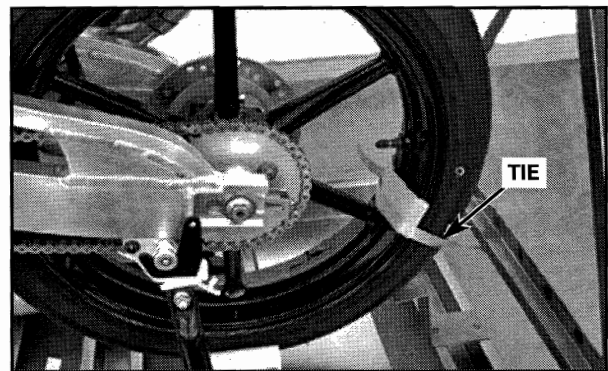

Remove the six bolts from each side of the crate frame.

Using two people, carefully lift off the crate frame to the side of the motorcycle.

Be careful not to damage the motorcycle while removing the crate frame.

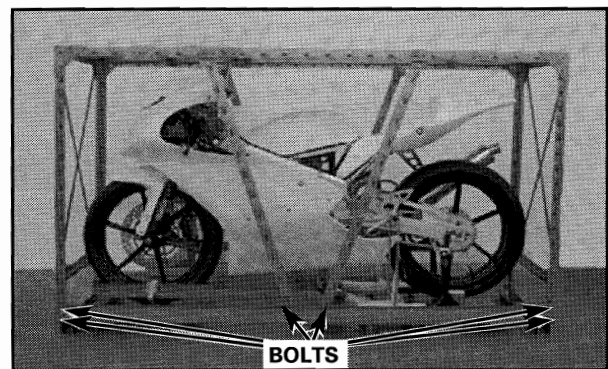

Remove the front shipping bracket and the vinyl tube from the top bridge. Be careful not to damage the upper cowl.

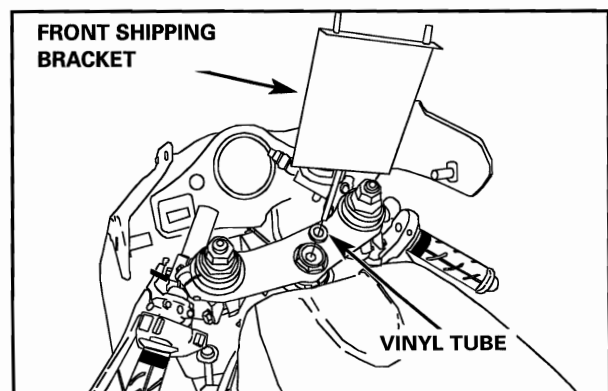



5. Remove the crate frame (cont.).

Remove the caution sheet from the tank cover.

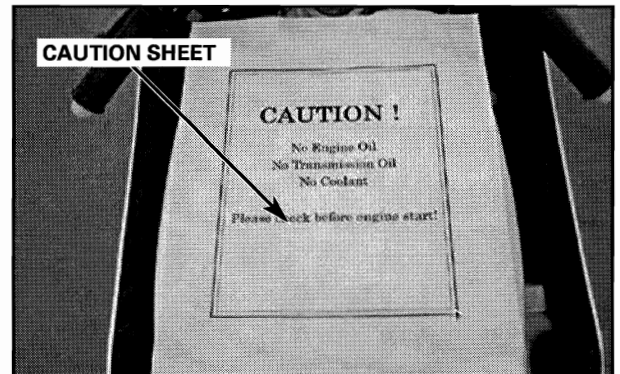

6. Remove the motorcycle from the crate base.

PARTS	QTY
Stand, rear	1

Cut and remove the ties from both sides of the motorcycle.

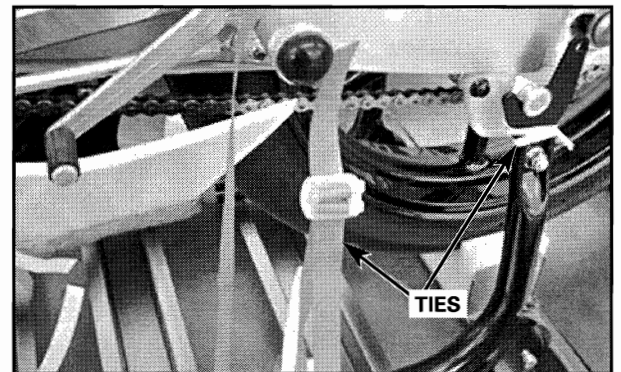

Attach a sling to the handlebars.

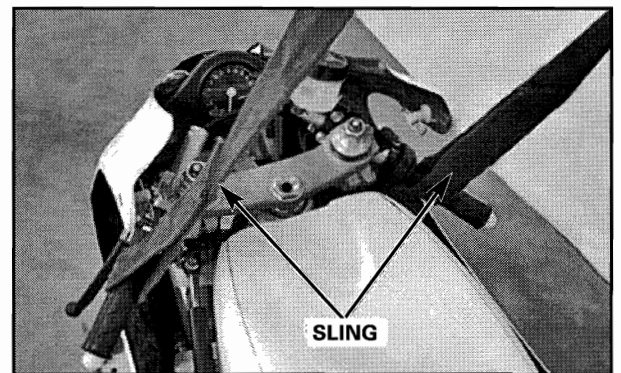

Attach a sling to the rear wheel, using a spreader and protective padding to protect the motorcycle.

Lift the motorcycle just enough to put tension on the slings.

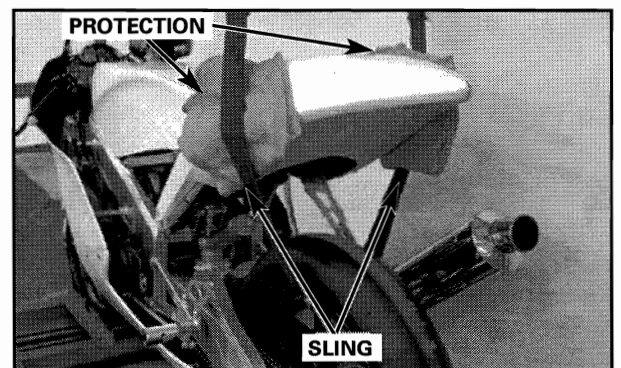

2008 MD250H

6. Remove the motorcycle from the crate base (cont.).

Lift the motorcycle free of the crate base and remove the base.

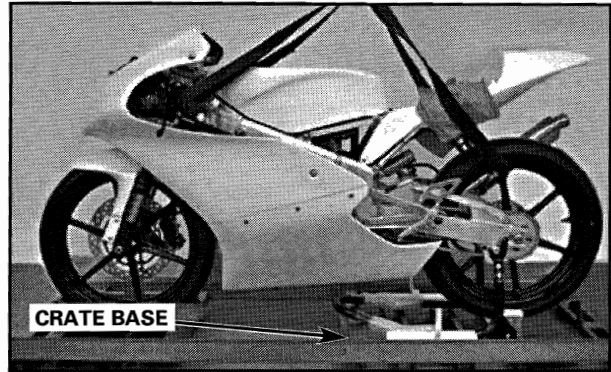

Place the motorcycle on a level surface and rest the motorcycle on its rear stand.

Remove the slings.

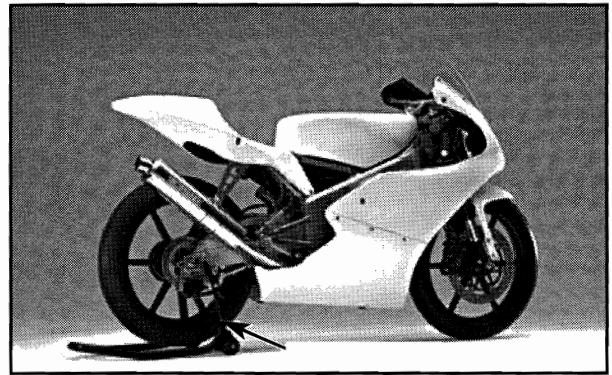

Clean both sides of the front and rear brake discs using brake cleaner and a clean shop towel.

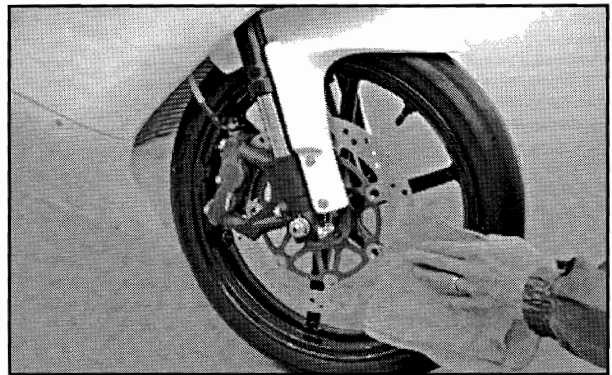

7. Attach the seat rubber (optional).

PARTS	QTY
Rubber, seat	1
Rubber, back seat	1

When installing the seat rubbers on the seat cowl, use double stick tape.

Note: This step is optional as the customer may want the seat rubbers placed in a certain position at time of delivery.

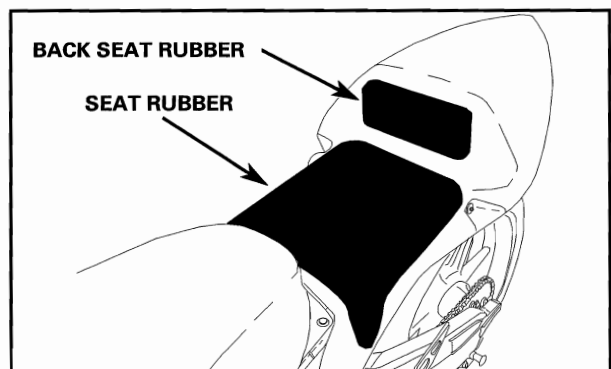



8. Remove all body panels.

Loosen the stud fasteners on both sides of the bike and remove the lower cowl.

Take the lock pins out from both sides of the bike and remove the upper cowl.

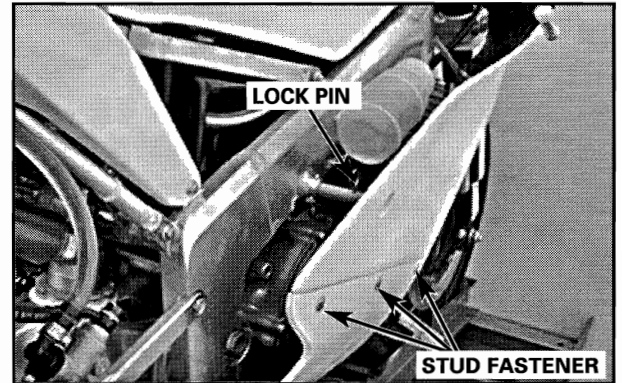

Loosen the bolts at both sides of the bike and remove the seat cowl.

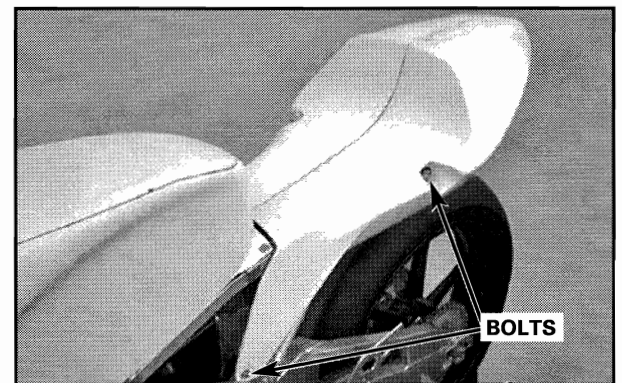

Remove the bolts and lock pin, then lift up the fuel tank cover.

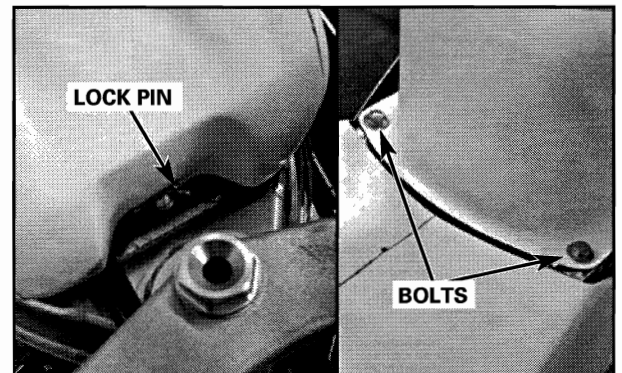

2008 MD250H

9. Check that the cables, hoses, and wire harnesses are properly routed.

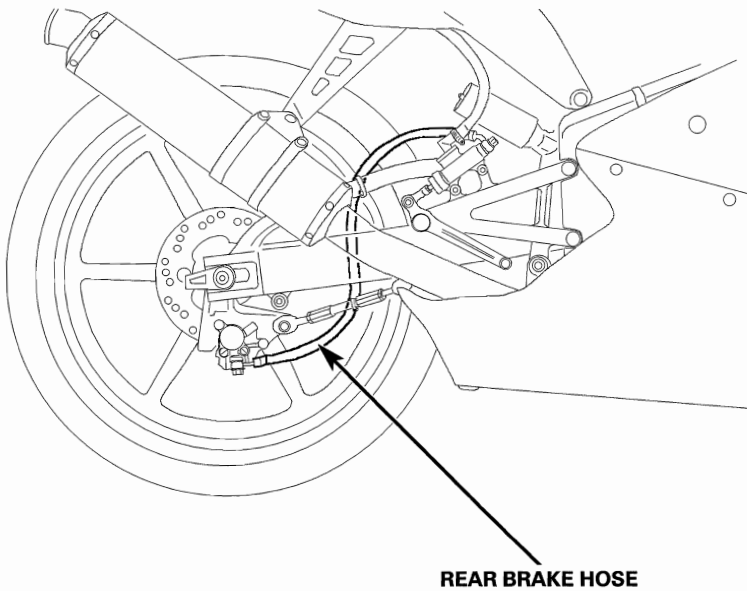
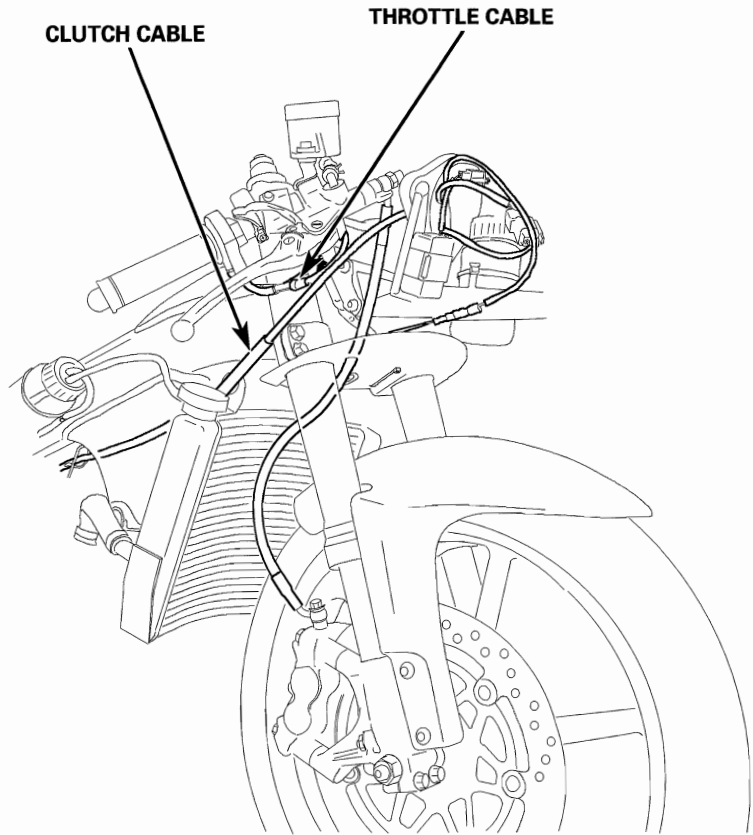
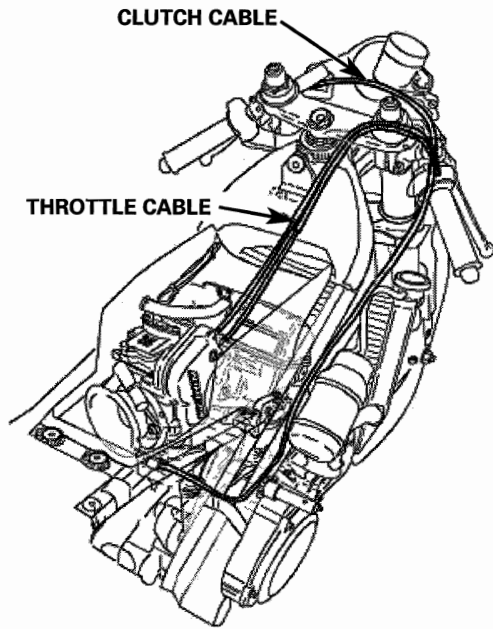



10. Service and install the battery.

PARTS	QTY
Battery	1
Rubber, cushion	1

Unpack the battery and service according to *Service Letter #48* and the information on the electrolyte container.

NOTE: Be careful as spilled electrolyte can damage frame and body parts.

Slide the battery terminal nuts into the battery terminals. Set the battery in its compartment and connect the positive (+) battery cable to the positive (+) battery terminal and the negative (-) battery cable to the negative (-) battery terminal using the terminal bolts.

Tighten the bolts securely, coat the terminals with dielectric grease, and pull the red cover over the positive terminal.

Install the battery rubber cushion on the battery.

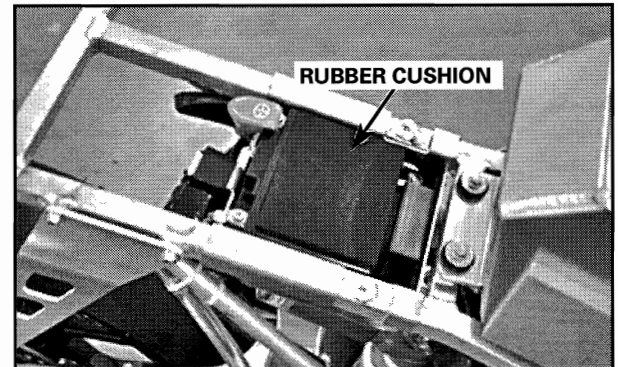
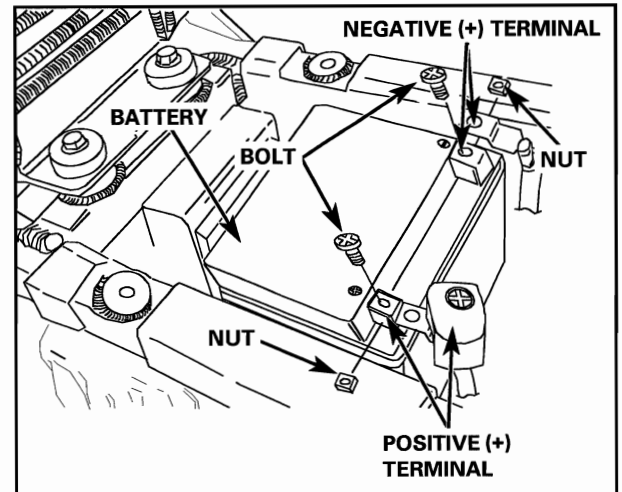

11. Adding oil to the engine.

Before adding oil to the engine, remove the anti-rust coating from the engine and exhaust system using a mild detergent and water.

Rinse with clean water.

Remove the oil filler cap/level gauge and add 0.85 liter of the recommended oil. Check that the oil level is near the middle of the UPPER and LOWER marks on the dipstick.



2008 MD250H

11. Adding oil to the engine (cont.).

- **Recommended engine oil: Pro Honda GN4 or equivalent 4-stroke engine oil. Use HP4S for racing application.**
- **Viscosity: SAE 10W-30 API classification: SG or higher. Do not use oils labeled as energy conserving on the circular API service label.**
- **JASO T 903 standard: MA**
- **Crankcase capacity: 0.66 Liters (0.70 US Quarts)**

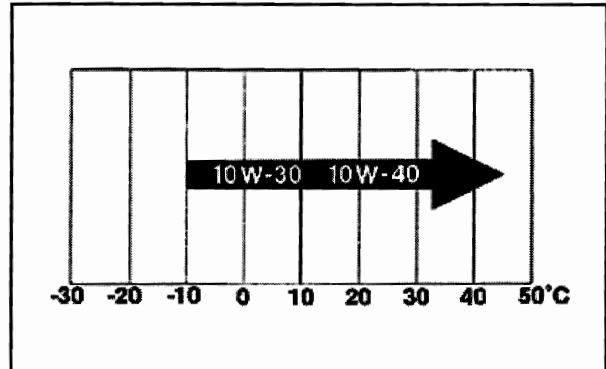

12. Add oil to the transmission.

Place an oil drain pan under the engine. Remove the oil filler cap, oil check bolt and sealing washer.

Add 0.75 liters of the recommended oil to the transmission.

- **Recommended transmission oil: Pro Honda GN4 or equivalent 4-stroke engine oil. Use HP4S for racing application.**
- **Viscosity: SAE 10W-30 API classification: SG or higher. Do not use oils labeled as energy conserving on the circular API service label.**
- **JASO T 903 standard: MA**
- **Transmission oil capacity: 0.75 Liters (0.79 US Quarts)**

A small amount of oil should flow out of the check bolt hole. If a large amount of oil comes out from the hole, let it drain until it stops.

If no oil flows out of the check bolt hole, add oil slowly through the oil filler hole until oil starts to flow out of the check bolt hole. Reinstall and tighten the oil filler cap and oil check bolt.

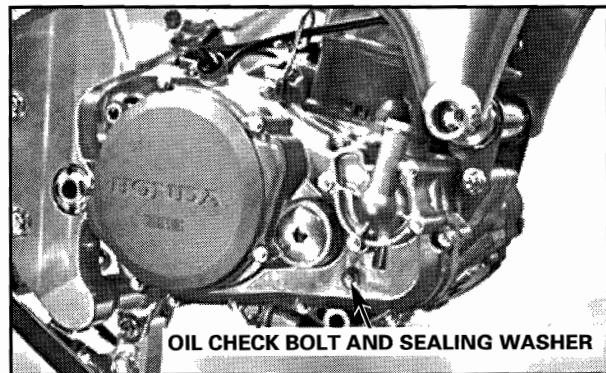
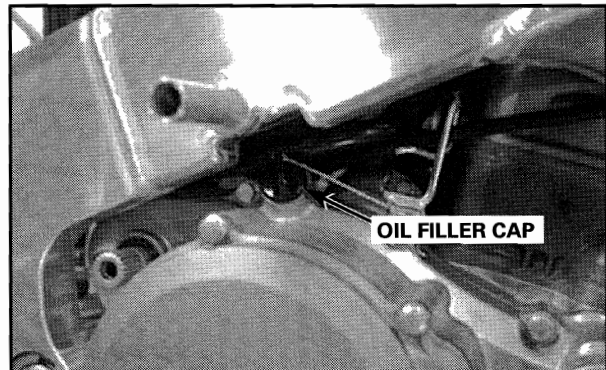



13. Add the coolant.

Remove the radiator cap and fill the radiator with distilled water to the filler neck.

- **Recommendation: Distilled water**

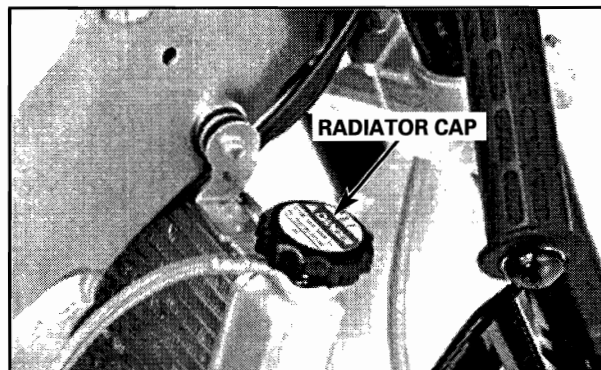

14. Check the engine oil level.

Use unleaded high octane gasoline.

Remove the carburetor protector (adhesive tape). See step 26 for more information.

Start the engine and let it idle for three minutes, then shut it off. Wait another three minutes before checking the oil level.

Support the motorcycle in an upright position on level ground. Remove the oil filler cap/level gauge and wipe it clean. Reinstall the oil filler cap/level gauge, but do not screw it back in. Remove the oil filler cap/level gauge and check that the oil level is between the UPPER and LOWER marks on the level gauge.

If required, add the recommended oil until the oil reaches the middle of the UPPER and LOWER marks.

Do not add oil above the UPPER mark.

Reinstall the oil filler cap/level gauge.

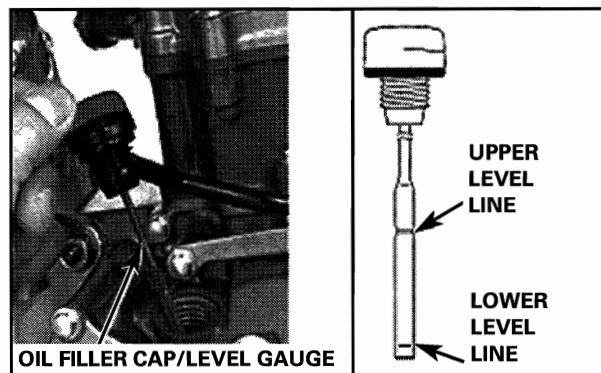

15. Check the transmission oil level.

Start the engine and let it idle for three minutes. Shut it off and wait another three minutes before checking the oil level. When checking it, allow any excess oil to flow out of the oil check bolt hole. Add the recommended oil if necessary.

Reinstall and tighten the oil filler cap and oil check bolt.

2008 MD250H

16. Check the coolant level.

Be sure to bleed any air trapped in the cooling system after **filling with distilled water**. Remaining air may cause the engine to overheat.

Air bleeding procedure:

- Remove the radiator cap and slowly fill the radiator with distilled water up to the filler neck.
- Loosen the drain bolt and release any trapped air.
- Hold the handle bars and lean the bike from left to right a few times to release air. If the coolant level drops, add more distilled water.
- Repeat the above procedure until the coolant level doesn't drop.
- With the radiator cap off, start the engine **ONLY** when it is cold. Check the level at the filler neck (coolant will not flow if there is trapped air in the system). Stop the engine and re-check the level. Add more distilled water if necessary, then reinstall the radiator cap.

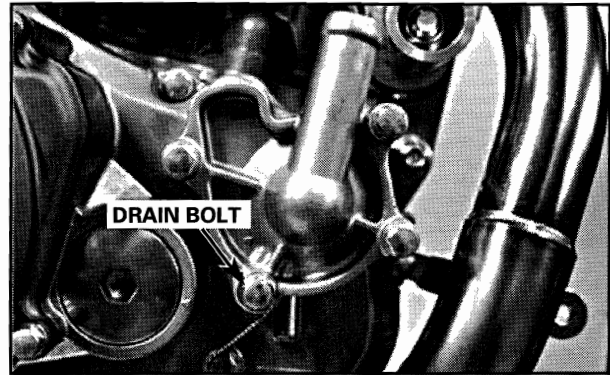

17. Check the throttle freeplay.

Operate the throttle to confirm that it moves smoothly and returns automatically from any open position to the fully closed position in all steering positions.

Confirm the throttle grip freeplay.

Freeplay: 1/16 - 1/4 in (2 - 6 mm)

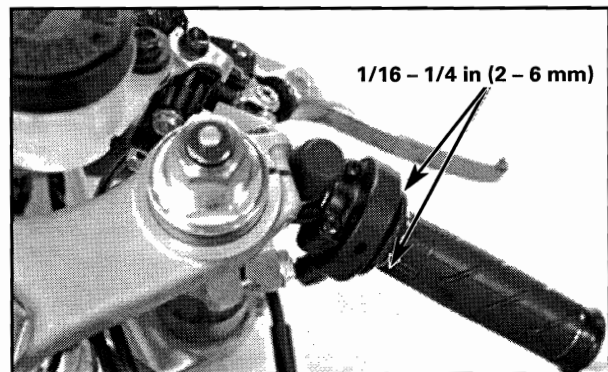

Make freeplay adjustments at the throttle grip adjuster by loosening the lock nut and turning the adjuster.

Tighten the lock nut after making the adjustment.

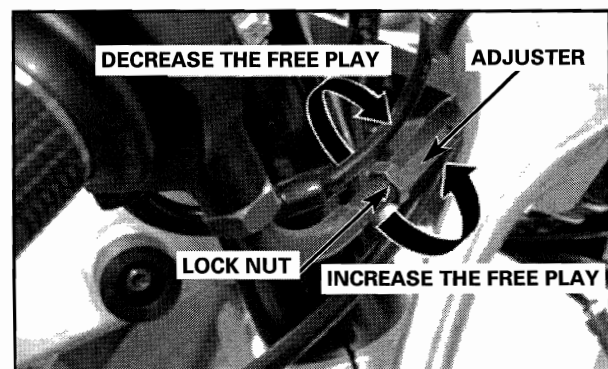



18. Check the clutch lever freeplay.

Confirm that the clutch lever freeplay is as specified at the lever tip.

Freeplay: 3/8 – 13/16 in (10 – 20 mm)

To adjust freeplay:

Make small adjustments at the lever end of the cable by loosening the lock nut and turning the adjuster.

Make large adjustments at the engine end of the cable by loosening the lock nut and turning the adjuster.

Tighten the lock nut after making the adjustment.

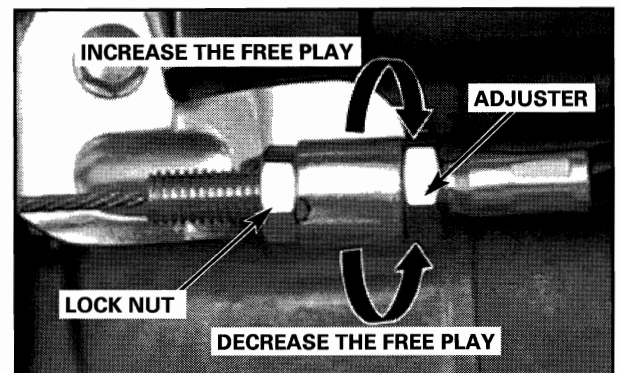
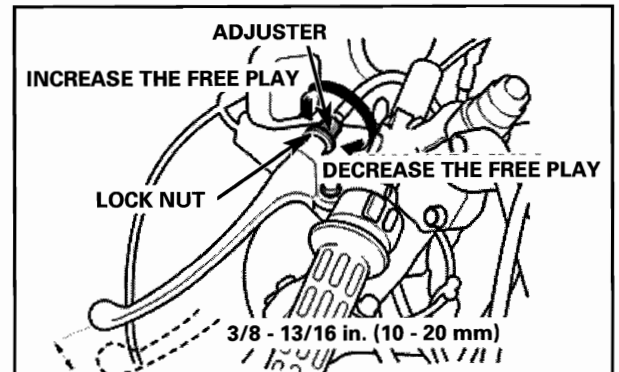

19. Check the fluid level in both brake reservoirs.

Place the motorcycle on a level surface. Turn the handlebar so that the front brake reservoir is level and check the fluid level through the inspection window.

If the fluid level is below the LOWER level mark, remove the cap and diaphragm.

Add fresh Pro Honda DOT 4 brake fluid from a sealed container.

NOTE: Brake fluid can damage plastics and paint, and can cause irritation to skin or eyes.

Reinstall the diaphragm and cap.

Tighten the screws.

A clear vinyl tube is used for the rear brake reservoir. Check the brake fluid level by measuring the distance from the top of the vinyl tube.

Fluid level: 40 – 50 mm

If the level is below the specified level at the rear reservoir, remove the plug from the rear brake reservoir.

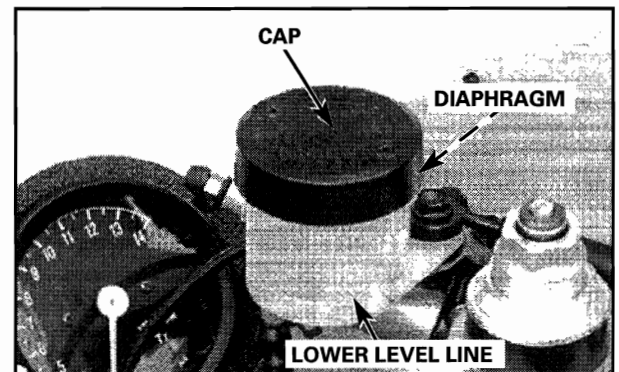

2008 MD250H

19. Check the fluid level in both brake reservoirs (cont.).

Add fresh Pro Honda DOT 4 brake fluid from a sealed container.

Reinstall the plug.

Operate the front brake lever and rear brake pedal. If the freeplay is excessive and the reservoir fluid level is correct, bleed the brake system. See the Service Manual for proper brake bleeding procedures.

20. Check the idle speed.

Remove the fuel tank cap.

Fill the fuel tank completely with fresh fuel. Support the motorcycle in an upright position.

Place the transmission in neutral.

Locate the fuel valve under the seat and behind the fuel line, and turn it to the ON position.

NOTE: Do not remove the fuel tank sponge when filling up, it is there to keep the fuel from sloshing while riding.

Start the engine and warm it to the normal operating temperature.

Verify that the engine idle speed is as specified.

Idle speed: 3200 ± 200 RPM

If adjustment is required, use the throttle idle screw to adjust the idle speed.

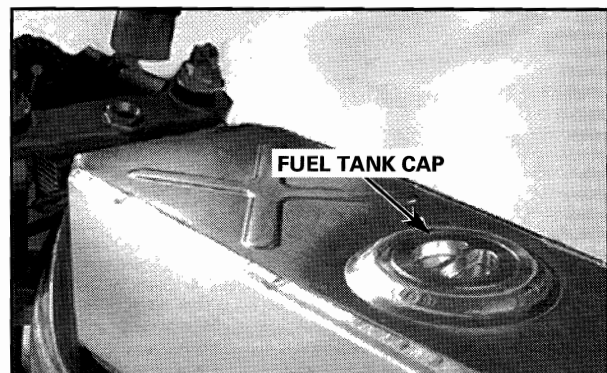

21. Verify drive chain slack.

Place the transmission in neutral and check the drive chain slack in the upper run, midway between the sprockets.

Chain slack: 13/16 ± 1/8 in (20 ± 2 mm)

Adjust the chain slack by loosening the rear axle nut.

Turn each adjuster bolt an equal amount to obtain the proper chain slack.

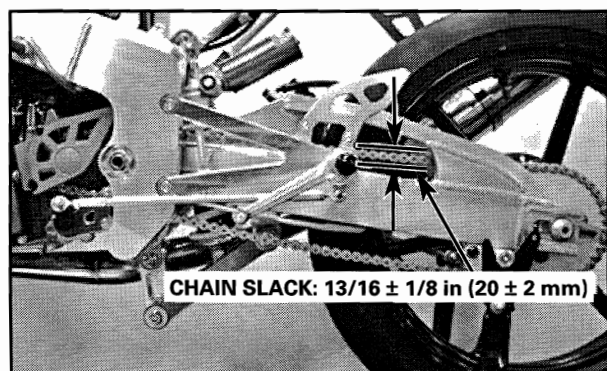



21. Verify drive chain slack (cont.).

Tighten the axle nut to the specified torque.

Torque: 69 N-m (7.0 kgf-m, 51 lb-ft)

Recheck the drive chain slack and make sure the wheel rotates freely.

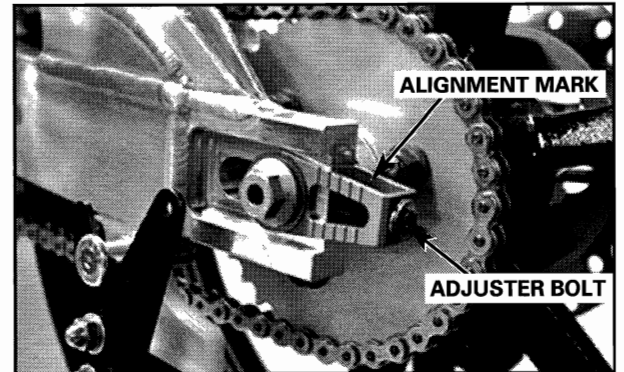

22. Check the air pressure in both tires.

Front: 25.6 psi

Rear: 27.0 psi

23. Reinstall all previously removed body panels.

Reinstall all previously removed body panels: lower cowl, upper cowl, seat cowl, and tank cover.

24. Install the windscreen.

PARTS	QTY
Windscreen	1
Rivets, 4 x 7 mm	7
Rivets, 4 x 8 mm (optional)	1

Install the windscreen to the front cowl using the 4 x 7 mm nylon rivets.

NOTE: Windscreen installation is easier when applying the bottom center rivet first and working your way UP to the top of the screen. The bottom center may require a longer rivet to install the windscreen. If so, use the 4 x 8 mm nylon rivet.

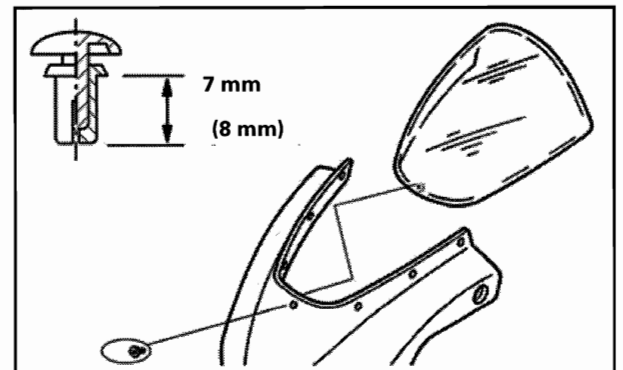

2008 MD250H

25. Install the front cowl upper stay.

PARTS	QTY
Stay, front cowl upper	1
Pin, lock	2

Insert bottom knob of the front cowl upper stay into the hole of the steering stem bolt.

Attach both ends of the stay to the cowl stay nuts of the front cowl.

Align the lock pin holes and insert the lock pins on both sides.

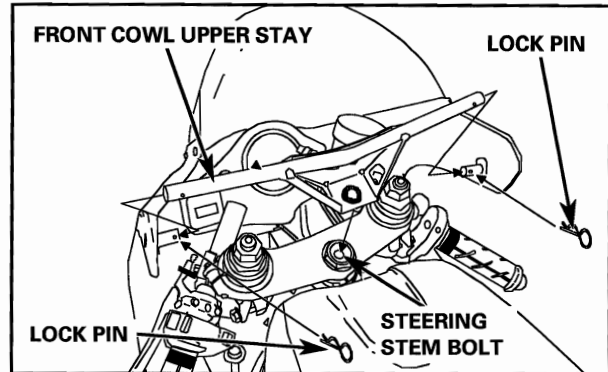

26. Instruct the customer on carburetor protector usage.

Explain to the customer the correct use of the carburetor protector. An adhesive tape is used for the carburetor protector.

The carburetor protector prevents contaminants from entering the carburetor when the motorcycle is not in use.

The carburetor protector should be removed before the engine is started and reinstalled when the engine is not in use, during transportation, and when stored.

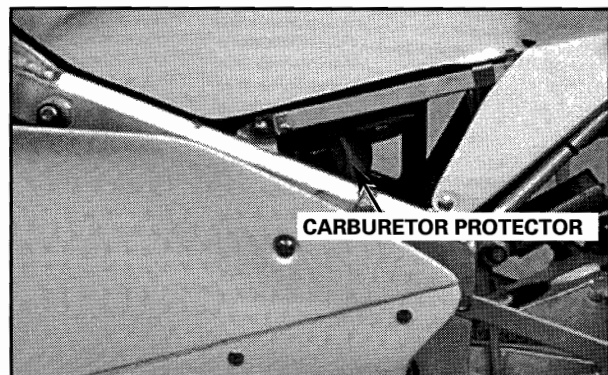

27. Complete the Set-Up/ Pre-Delivery form.

Complete a *On-Road Set-Up/Pre-Delivery Checklist* form by checking the boxes confirming that the steps were done.

NOTE: The *On-Road Set-Up/Pre-Delivery Checklist* form is available on **iN**.

Log onto **iN**.

Click **Service Publications** from the **Service** tab.

Click **Forms Library**.

Under **Category** and **Document Type**, select the form you need, then click **Search**.

After the PDF form loads, click the **Print** button. You will need two copies – one for your records, and one for your customer. Another option is to print one copy, fill in the information, then photocopy it.



Wiring Diagram

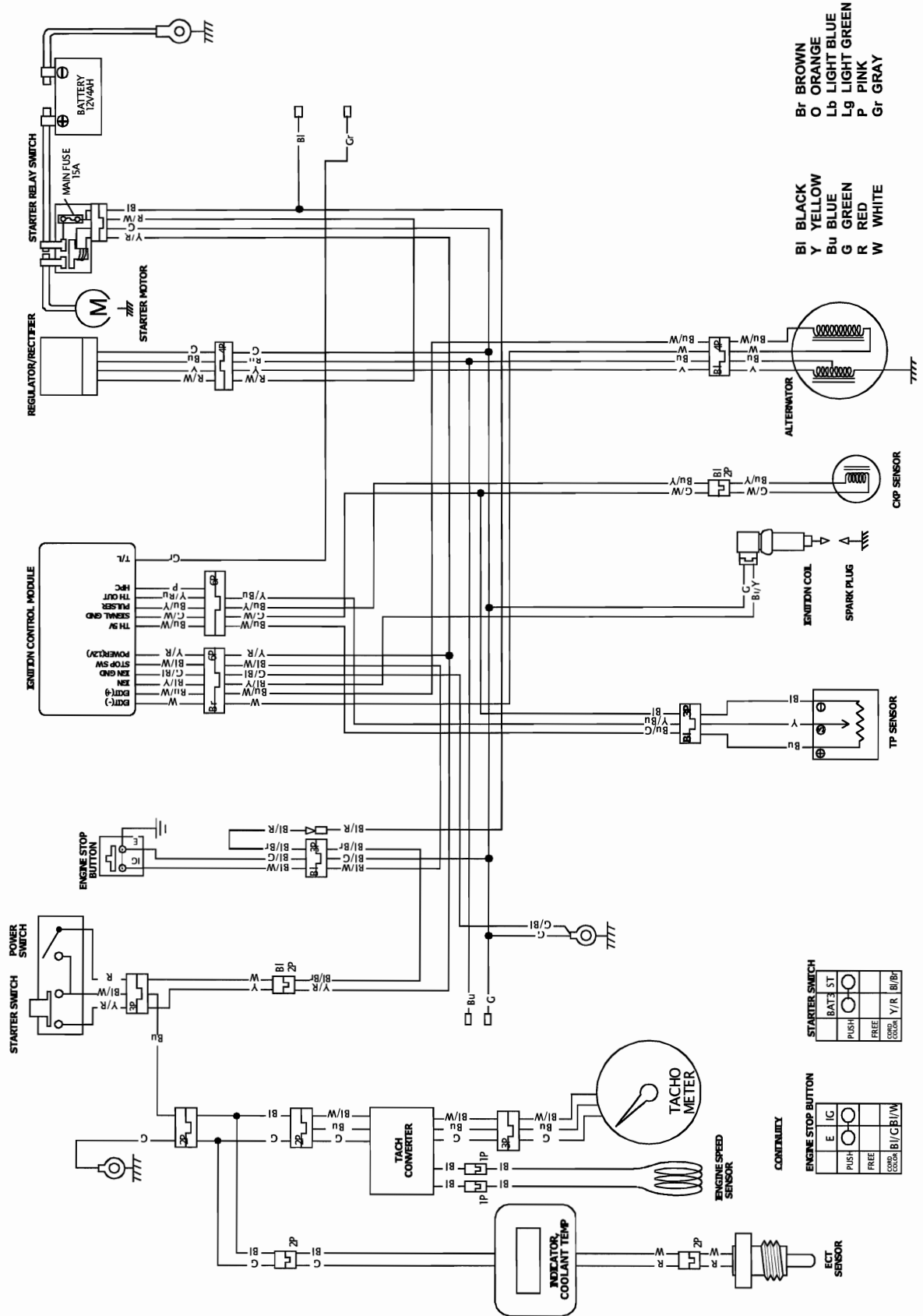

Br BROWN
 O ORANGE
 Lb LIGHT BLUE
 Lg LIGHT GREEN
 P PINK
 Gt GRAY

BI BLACK
 Y YELLOW
 Bu BLUE
 G GREEN
 R RED
 W WHITE

STARTER SWITCH

BATS	ST		
PUSH	FREE	COMP.	Y/R

ENGINE STOP BUTTON

E	IG		
PUSH	FREE	COMP.	BI/CB/W

CONTINUITY

(

(

(

(

(

(

(